

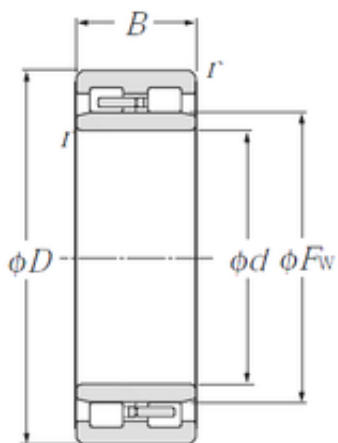

China Kubota Hydraulic Final Drive Mo...



NNU4988 NTN Tapered Roller Bearing

Bearing No. NNU4988

Dimensione	440x600x160 mm
Marchio	NTN
Diametro del foro	440 mm
Diametro esterno	600 mm
Larghezza	160 mm
d	440 mm
Fw	492 mm
D	600 mm
B	160 mm
C	160 mm
r min.	4 mm
Peso	127 Kg
Carico dinamico di base (C)	2 150 kN
Carico statico di base (C0)	5 550 kN
(Grease) Velocità di lubrificazione	850 r/min

NNU4988 Bearing 2D drawings and 3D CAD models