

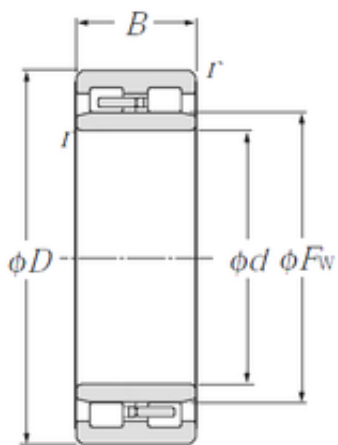

China Kubota Hydraulic Final Drive Mo...



NNU4984 NTN Tapered Roller Bearing

Bearing No. NNU4984

Dimensione	420x560x140 mm
Marchio	NTN
Diametro del foro	420 mm
Diametro esterno	560 mm
Larghezza	140 mm
d	420 mm
Fw	465 mm
D	560 mm
B	140 mm
C	140 mm
r min.	4 mm
Peso	92 Kg
Carico dinamico di base (C)	1 740 kN
Carico statico di base (C0)	4 500 kN
(Grease) Velocità di lubrificazione	900 r/min

NNU4984 Bearing 2D drawings and 3D CAD models